



Société Nationale de
Certification et d'Homologation

Société à responsabilité limitée











October 14th, 2011

STATEMENT

We confirm, that the following replacement silencer type 5512, produced by SITO Gruppo Industriale S.p.A. (S.G.I.), is complying with

- the EC-Directive 97/24/EC Chapter 9 regarding permissible sound level and exhaust system

An EC type approval number has been granted by the luxembourgian Ministry for Sustainable Development and Infrastructure, department of Transport, for the following version of the above mentioned replacement silencer type:

Silencer Version	Drawing No.	Type approval number	Vehicle type	Vehicle Model
5513	5513	SGI  0497 	S1A – VGAS1A01	PEUGEOT SQUAB 50
5513	5513	SGI  0497 	S1B00-B – VGAS1B00B- VGAS1B00A – S1B –S1BDE – S1BKB – S1B0KB	PEUGEOT SPEEDFIGHT (Liquid)
5513	5513	SGI  0497 	S1B – VGAS1 – BOKKA – S1BDE – S1BOKA – S1B0KA – S1BOKF	PEUGEOT SPEEDFIGHT (Air)
5513	5513	SGI  0497 	S1AOKF	PEUGEOT METAL-X 50
5513	5513	SGI  0497 	S1 Var.3B Vers.A4	PEUGEOT X-FIGHT 50 Kat



Gilles AST
Expert Technique

Adresse:
BP 23
L-5201 Sandweiler

Siège social:
11, route de Luxembourg
L-5230 Sandweiler

Capital social: 3.500.000 €
R.C. B 27180
N° TVA: LU 13770825

Tél.: (+352) 35 72 14 - 250
Fax: (+352) 35 72 14 - 244
E-mail: info@snch.lu
Home page: www.snch.lu



9932930

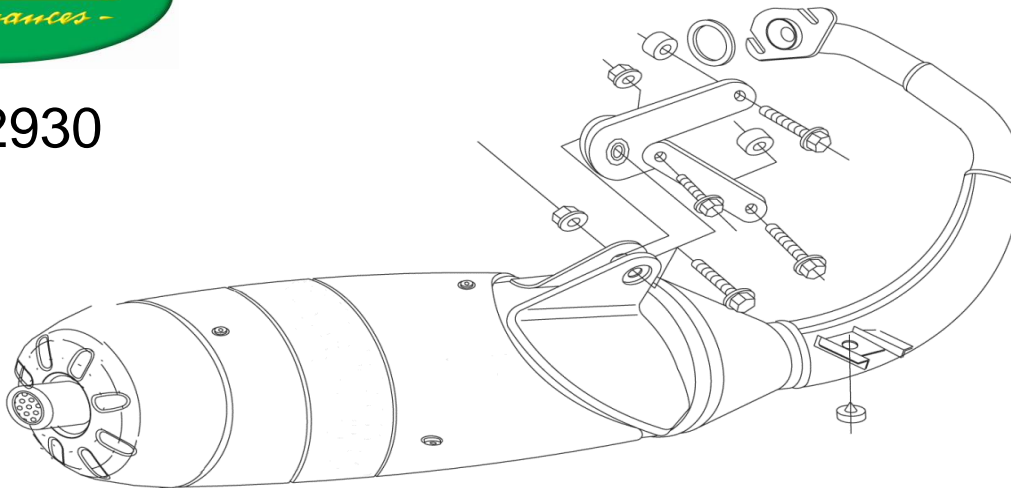

RULLI E MOLLE - ROLLERS AND SPRINGS - MASSELOTTES ET RESSORTS - ROLLEN UND FEDERN - RODILLOS Y MUELLES

RULLI: (art. 4646 – gr 8,0 solo per PEUGEOT SQUAB e METAL-X 50) - **MOLLE:** (PIAGGIO HARD GIALLE per PEUGEOT SQUAB - SPEEDFIGHT H2O- METAL-X 50 e PIAGGIO MEDIUM ROSSA per PEUGEOT SPEEDFIGHT AIR e X-FIGHT).

ROLLERS: (art 4646 – 8,0 g. for PEUGEOT SQUAB - METAL-X 50) - **SPRINGS:** (PIAGGIO HARD YELLOW for PEUGEOT SQUAB - SPEEDFIGHT H2O -METAL-X 50 and PIAGGIO MEDIUM RED FOR PEUGEOT SPEEDFIGHT AIR and X-FIGHT).

MASSELOTTES: (ref. 4646 - 8,0 grammes seulement pour PEUGEOT SQUAB - METAL-X 50) - **RESSORTS:** (PIAGGIO HARD JAUNES pour PEUGEOT SQUAB - SPEEDFIGHT H2O - METAL-X 50 et PIAGGIO MEDIUM ROUGE pour PEUGEOT SPEEDFIGHT AIR et X-FIGHT).

RODILLOS: (art. 4646 – gr. 8,0 para PEUGEOT SQUAB - METAL-X 50) - **MUELLES:** (PIAGGIO HARD AMARILLO para PEUGEOT SQUAB - SPEEDFIGHT H2O - METAL-X 50 y PIAGGIO MEDIUM ROJO para PEUGEOT SPEEDFIGHT AIR y X-FIGHT).

ROLLEN: (Art. 4646 - gr. 8,0 für PEUGEOT SQUAB - METAL-X 50) - **FEDERN:** (PIAGGIO HARD GELBE für PEUGEOT SQUAB - SPEEDFIGHT H2O - METAL-X 50 und PIAGGIO MEDIUM ROT für PEUGEOT SPEEDFIGHT AIR und X-FIGHT)

**DISEGNO TECNICO RULLI E MOLLE - TECHNICAL DRAWING ROLLERS AND SPRINGS
CROQUIS TECHNIQUE MASSELOTTES ET RESSORTS - TECHNISCHE ZEICHNUNG ROLLEN UND FEDERN
DISEÑO TÉCNICO RODILLOS Y MUELLES**

FIGURA 1

- * Battuta rullo
- * Roller beat
- * Retour plastique
- * Anschlag der rolle
- * Batiante de rodillo



FIGURA 2

Senso di rotazione
Clock-wise rotation
Sens de rotation
Drehrichtung
Sentido de rotación

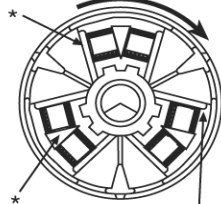

- * Battuta rullo
- * Roller beat
- * Retour plastique
- * Anschlag der rolle
- * Batiante de rodillo

MOLLE DA SOSTITUIRE - SPRINGS TO BE REPLACED
RESSORTS À REMPLACER - ZU ERSETZENDE FEDER
MUELLES PARA SUSTITUCIÓN

FIGURA 3

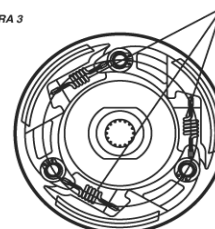

Frizione a 3 molle
3 springs clutch
Embrajage à 3 molle
3-feder-kupplung
Friccion con 3 muelles

FIGURA 4

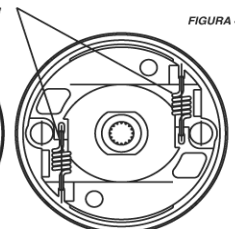

Frizione a 2 molle
2 springs clutch
Embrajage à 2 ressorts
2-feder-kupplung
Friccion con 2 muelles

VISTA DAL LATO INTERNO - VIEW FROM THE INNER SIDE
VUE DE L'INTERIEUR - ANSICHT VON INNENSEITE
VISTA DESDE EL LADO INTERIOR